

# MRR-2

## Micro Rain RADAR

### User Manual



METEK  
Meteorologische Messtechnik GmbH

Fritz-Strassmann-Strasse 4  
D-25337 Elmshorn  
Germany

Fon +49 4121 4359-0  
Fax +49 4121 4359-20  
e-mail [info@metek.de](mailto:info@metek.de)  
internet <http://www.metek.de>

01.2008 Version 4.12 / 4.15

Copyright: © 2008 METEK GmbH

All Rights reserved. No part of this manual may be reproduced, transmitted, stored in a retrieval system, nor translated into any human or computer language, in any form or by any means, electronic, mechanical, optical, chemical, manual, or otherwise, without the prior written permission of the copyright owner.

07.2009 Version 5.2.0.1





## Table of Contents

<b>1</b>	<b>Safety Precautions</b> .....	<b>3</b>
<b>2</b>	<b>How to use this manual</b> .....	<b>5</b>
<b>3</b>	<b>Measuring Principle</b> .....	<b>6</b>
<b>4</b>	<b>System Description</b> .....	<b>7</b>
4.1	Overview .....	7
4.2	Description of the Components.....	8
4.2.1	Parabolic Dish.....	8
4.2.2	Antenna Heating (Option) .....	8
4.2.3	RADAR Control and Processing Device and Transceiver.....	9
4.2.4	Junction Box / Power Supply .....	9
4.2.5	Cable RCPD-Junction Box.....	11
4.2.6	Cable Junction Box-PC.....	11
4.2.7	Control- and Evaluation Computer (PC) .....	12
<b>5</b>	<b>Hardware Installation</b> .....	<b>13</b>
5.1	General Provisions.....	13
5.2	Site Conditions.....	13
5.3	Installation Procedure .....	14
<b>6</b>	<b>Control Program</b> .....	<b>16</b>
6.1	Installation.....	16
6.2	Using the Control Program.....	16
6.2.1	Main Menu .....	19
6.2.2	Control Commands Menu .....	20
6.2.3	Output Parameters Menu.....	20
6.2.4	Device Parameters Menu.....	23
6.2.5	Parameter Storage.....	24
6.2.6	Status messages and time-axis control .....	27
6.3	Instantaneous and averaged data .....	30
6.3.1	Format description .....	30
6.3.2	Example .....	35
6.4	Raw data.....	38
6.4.1	Format Description.....	38

6.4.2	Example .....	39
6.5	Removing of the Software .....	40
<b>7</b>	<b>Detailed description of the MRR-2 control program .....</b>	<b>40</b>
7.1	Communication-, Data-, and Error-Service (CDES) .....	41
7.1.1	Communication Service .....	41
7.1.2	Data Recording .....	41
7.1.3	Error Protocol .....	42
7.2	Control Program User Interface (CPUI).....	43
<b>8</b>	<b>MRR-2 Specifications.....</b>	<b>46</b>

# 1 Safety Precautions

---

To operate the MRR-2 a mains voltage of 210-240 VAC is needed for the power supply. An improper handling can be dangerous to you. Only competent and instructed persons should work with this system or with parts of it.

The outdoor installation must not be performed in case of an approaching thunderstorm, to avoid a possibly endangering of personnel by lightning.

There are not known any health hazards originating from the emitted electromagnetic radiation of about 50 mW. Nevertheless you should take care that everybody keeps out of the beam above the antenna (parabolic dish) when it is in operation.

All connecting cables, plugs, and couplings of the MRR-2 are not interchangeable to prevent any erroneous assembly. This safety precaution is disabled if other types of plugs are installed by the user. Therefore any guarantee explicitly expires and METEK accepts no responsibility for injuries to persons, damage of equipment or other consequences connected with not authorized changing of connectors, cables or other parts of the system.

Depending on regional rules for the use of electromagnetic transmitters frequency permission might be necessary. The operator of the system will be liable for the achievement of such permission. However METEK will be of help with providing adequate information. Copies of the certifications for Germany can be found in chapter 6 of this manual.





## **2 How to use this manual**

The delivered hardware items are described in section 4. Make sure that the delivery is complete and free of damage. Consult section 5 for setting up the hardware. In section 6 the installation and use of the control software is described. The technical specifications are listed in section 8.

Section 7 contains more detailed information which is not needed for standard operation.

All auxiliary information marked by a grey vertical line on the left margin may be skipped at first reading as it is not needed for standard setting up and operation.

### 3 Measuring Principle

---

The Micro Rain Radar MRR-2 retrieves quantitative rain rates, drop size distributions, radar reflectivity, fall velocity of hydro meteors and other rain parameters simultaneously on vertical profiles up to several kilometers above the radar.

It operates with electromagnetic radiation at a frequency of 24 GHz with a modulation of 0.5 – 15 MHz according to the height resolution (e.g. 300 m – 10 m). The radiation is transmitted vertically into the atmosphere where a small portion is scattered back to the antenna from rain drops or other forms of precipitation.

Due to the falling velocity of the rain drops antenna there is a frequency deviation between the transmitted and the received signal (Doppler frequency). This frequency is a measure for the falling velocity of the rain drops. Since drops with different diameters have different falling velocities the backscattered signal consists of a distribution of different Doppler frequencies. The spectral analysis of the received signal yields a power spectrum which is spread over a range of frequencies lines corresponding to the Doppler frequencies of the signal.

The RCPD determines this power spectrum with a high time resolution (25 per second) and sends mean power spectra every 10 s to the connected control and data acquisition system, where the reflectivity spectrum is calculated considering the calibration parameters of the RADAR module. Using known relations between fall velocity, rain drop size and scattering cross section the drop spectrum (or drop size distribution) is derived. The integration over the entire drop size distribution, considering further correction terms, followed by further averaging over 10 to 3600 seconds, results in rain rate and liquid water content.

The output signal of the RADAR is transmitted continuously (CW mode), a linearly decreasing saw tooth modulation of the transmit signal (FM mode) makes it possible to perform profile measurements with selectable range resolution.

The RADAR antenna is an offset parabolic dish with vertical beam orientation. This antenna design allows rainwater to drain without building ponds. In order to avoid disturbances from snow, which could cover the antenna dish, optional antenna heating is offered.

## 4 System Description

---

### 4.1 Overview

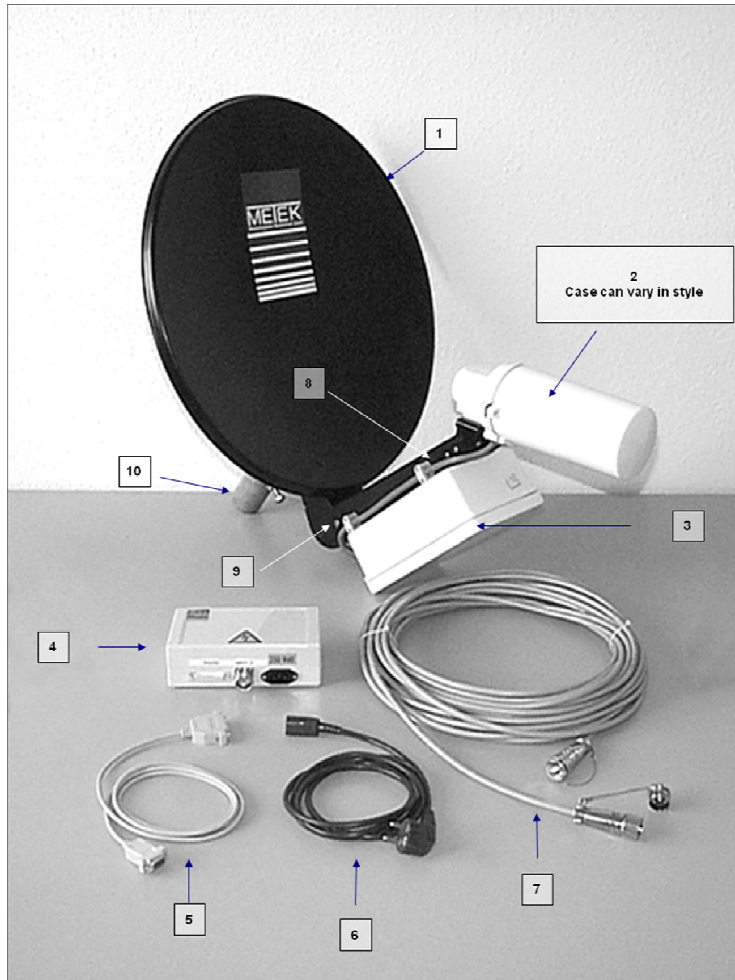

1. Parabolic Dish,
2. Transceiver,
3. RCPD,
4. Junction Box,
5. Cable Junction Box-PC,
6. AC Power Cable,
7. Cable RCPD-Junction Box,
8. Antenna Arm,
9. Pivot,
10. Tube Socket

**Figure 1 Components of the System**

The Control- and Evaluation Computer, a commercial PC, (not part of delivery) must be ordered separately. The operating system must be Windows® 2000 or XP. (Windows® Vista and Windows 7 is not supported).

## 4.2 Description of the Components

---

### 4.2.1 Parabolic Dish

The antenna is used for the transmission of the RADAR signals and the receiving of backscattered signals. It is designed as an offset parabolic dish (1). Its largest diameter is 70 cm, the beam width is 2°. Due to the offset-design of the parabolic dish rainwater can drain off.

For antenna mounting the tube socket (10) (inner  $\varnothing = 49.4$  mm, outer  $\varnothing = 54.4$  mm) is to be plugged onto a pole with an outer diameter of max. 49 mm. The socket is fastened with an M10 screw (10 mm  $\varnothing$ ).

**Connect a ground wire to this screw which serves as a surge protector.**

The pivot (9) is factory-adjusted, so that vertical orientation of the mounting tube socket results in a vertical orientation of the antenna beam. (Ignore the scale on the pivot).

**The parabolic dish must not be moved in its pivot (9), because this would cause beam deviations from vertical and would result in erroneous measurements.**

The transmitting and receiving properties of the antenna affect the radar calibration. Therefore the reflector surface should be clean (e.g. free from leaves or wet snow). For the same reason any mechanical deformation of the parabolic dish must be avoided. If nevertheless obvious deformation occurred, the reflector must be replaced.

### 4.2.2 Antenna Heating (Option)

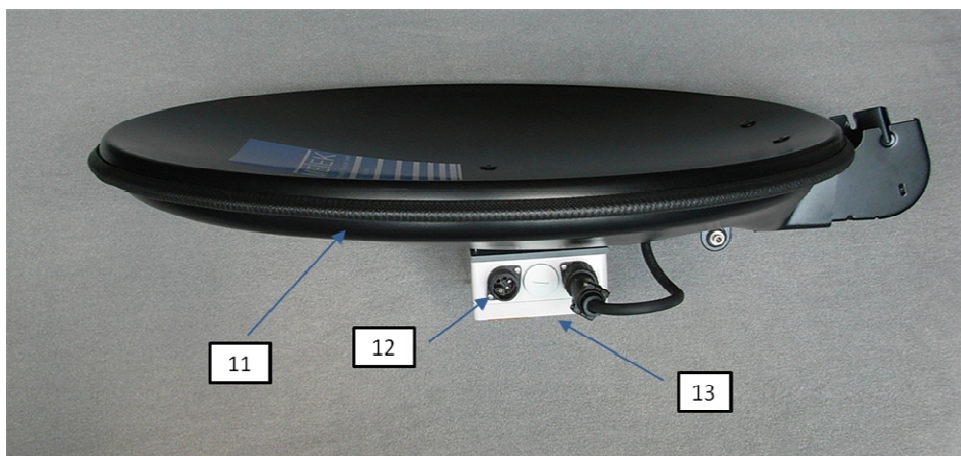

**Figure 2 Antenna Heating**

The back side of the reflector is optionally equipped with a heating coil. It is covered and sealed with a molded lid (11) which provides also extra stability for the reflector. The energy consumption increases with decreasing temperatures and amounts to maximum 500 W. The heating is activated when the temperature falls below a threshold which can be adjusted in the heating-junction box (13). The heating coil works with 230 VAC voltage supply and needs an extra power cable which is connected to (1).

### 4.2.3 RADAR Control and Processing Device and Transceiver

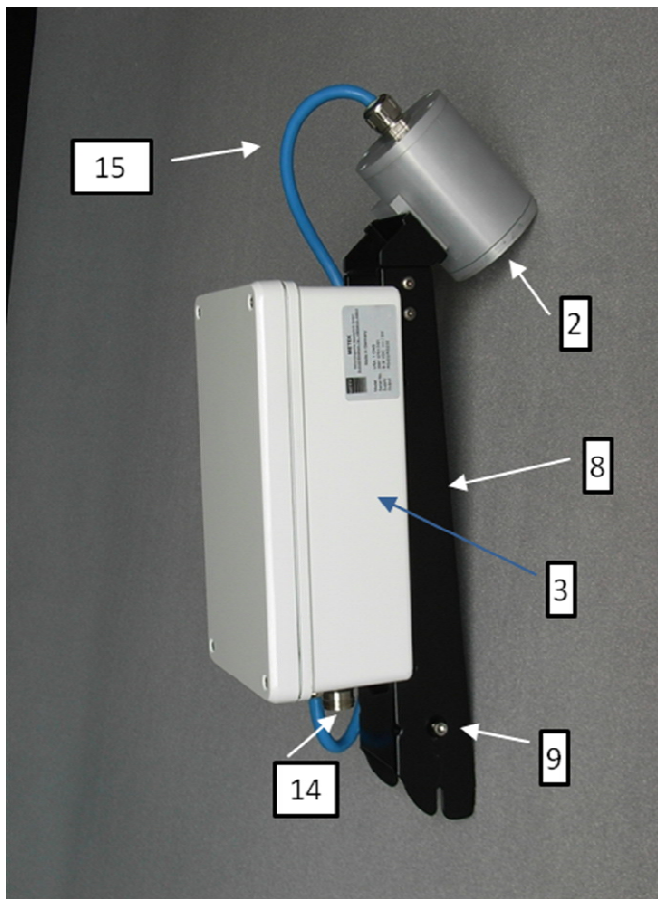

**Figure 3 RCPD and Transceiver**

The RCPD (3) generates the RADAR transmit modulation signal and passes it to the transceiver (2) through cable (15). It analyses the back-scattered receiver signal, calculates Doppler spectra and transfers average power spectra (referred to as “raw data”) to the control and evaluation PC, where these spectra are interpreted. The RCPD is located in a water protected IP65 housing, which is fixed to the antenna arm (8). At the bottom side of the RCPD is the socket (14) for cable (7). The electronic components inside the housing don't need any service. As far as possible the RCPD should not be opened by the user.

### 4.2.4 Junction Box / Power Supply



**Figure 4 Junction Box Left:Front Side, Right: Back Side**

The junction box is used to pass through the communication between the PC and the RCPD. For this purpose it has a 25-pin D-sub-miniature socket, (16) for the data cable (5) to the PC and a flanged socket (17) for the cable (7) to the RADAR RCPD (3).

The power supply for the RCPD and Transceiver is also integrated in the junction box. An IEC connector for the mains supply of 230 VAC (17) is on the front side of the case. On the back side are two sockets for banana plugs for the connection of an alternative external DC power supply (19). The power supply (24 VDC) for the RCPD and Transceiver is also passed through cable (7).

Note : The junction box is not appropriate for outdoor operation.

#### 4.2.5 Cable RCPD-Junction Box



**Figure 5 Cable between Junction Box and RCPD**

The cable has a length of 25 m, on both ends are screwed plugs (male and female respectively). They must be screwed onto the matching plugs at the junction box (cable has pins) and at the RCPD (cable has sockets).

#### 4.2.6 Cable Junction Box-PC



**Figure 6 Cable Junction Box-PC**

Data cable with a 9-pin (female) and a 25-pin (male) plug and a length of 1.5 m is delivered. This cable is not appropriate for outdoor applications.

#### 4.2.7 Control- and Evaluation Computer (PC)

A personal computer (PC) with the operating system Windows® 2000 or XP serves for setting the operation parameters and data evaluation of the MRR. (Windows® Vista and Windows® 7 are not supported).

The PC must have at least one serial port which will be configured by the control program as follows:

57600 baud,  
8 data bits, no parity,  
software protocol (XON/XOFF), no hardware protocol (handshake).

Pinning (D-Sub-25-socket at the device) :

Pin 2	RD	<i>received data</i>	to the device
Pin 3	TD	<i>transmitted data</i>	from the device
Pin 7	GND	<i>ground</i>	

The control program which is needed to operate the MRR-2 is part of delivery. Its installation and operation is described in section 6 *Control Program* page 16.



## 5 Hardware Installation

---

### 5.1 General Provisions

- Before you start the system, all cable connections must be set up.
- Only the antenna unit including RCPD, Transceiver and cable (7) are designed for outdoor operation. All other components, e.g. the junction box and PC, must be installed in a weather protected environment with temperatures within 5 - 50 °C.
- The electronic cases may be opened only in dry environment. Especially in outdoor area you risk damage by moisture.
- If cables are laid on free field, a cable conduit is recommended.
- All cable connections should be protected by strain-reliefs.
- Use only the original connectors. Guarantee is void, if other connectors are installed.

### 5.2 Site Conditions

Before actual installation the site must be checked for its suitability for rain measurements.

There must be free view of at least 10° zenith angle over the radar.

Nearby transmitters (base stations of mobile phones, broadcast towers, radars) can cause interference although they operate nominally at different frequency bands. If such neighborhood is necessary, a simple metallic screen or larger object (container) obscuring the direct line of sight to the interfering source can help.

The vicinity of electric machines (e.g. drive of elevators) should be avoided, since they can create interfering signals which are difficult to screen.

If measurements at very low heights are planned, (with appropriate settings the MRR-2 allows measurements from a minimum height of 20 m above ground) take care that the wind field in this level is not disturbed by nearby buildings, trees, masts etc., because strong turbulence could falsify the data.

In contrast with in-situ rain sensors the exposure of the antenna to the free wind field is not detrimental but favorable.

Figure 7 shows various examples of MRR installations: On ground, on top of containers and on top of buildings.



**Figure 7 Examples of MRR installations**

### 5.3 Installation Procedure

---

#### **Preparations:**

A fixed vertical pole ( $\varnothing$  max. 49 mm, length min. 30 cm) is required for attaching the antenna. Operating of the MRR-2 requires a 230 VAC mains supply, with a fuse protection of 8 A (slow) minimum. To prevent disturbance of the device by variations or breaks of the power supply we recommend the use of a no-break power supply (UPS).

**Required Tools:** A wrench with 17 mm opening.

### Installation Steps:

1. Install the control and evaluation computer (PC) according to the documents of the manufacturer.
2. Plug the tube socket (10) of the RADAR antenna over the attachment pole and clamp it with the M10 fixing bolt.
3. Check the vertical alignment of the antenna with the built in bubble level (see Figure 8)

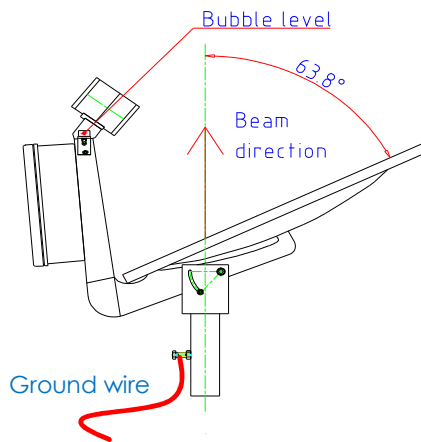

**Figure 8 Vertical alignment of the radar beam**

4. Attach a ground wire to the fixing bolt for lightning protection.
5. Connect cable (7) between RCPD and Junction Box after mounting of the antenna.
6. Connect cable (5) to that serial interface of the computer, which was selected in the operating system for the connection of the MRR-2. If this serial port is unknown, it can be looked up in the administration of the "services" in the operating system of the computer and it can be changed accordingly there. See also installation of the control program page 16 ff.
7. Connect cable (6) of the Junction Box to the mains voltage of 230 VAC (cable (6)).
8. Establish the communication between the control program „MRR-2 Control” and the RCPD-firmware.
9. Check the correct data transmission and recording.

## 6 Control Program

---

If the PC for controlling the MRR-2 with was not ordered separately the programs for controlling the MRR-2 and for data recording are delivered on a CD-ROM and must be installed on a PC with operating system **Windows® 2000 or Windows® XP**. (Older Windows® versions, Windows® Vista, or Windows® 7 are not supported.)

If the PC was configured and delivered by METEK (optional) **6.1 Installation** may be skipped.

### 6.1 Installation

For installing the Control Program:

- Insert the CD-ROM.
- Login as administrator.
- Open the program group `my computer` (icon on the desktop).
- Open the folder for the CD-ROM device.
- Change to the folder `METEK\MrrCtrl`.
- With the right mouse key click on the file `MrrXXXXXX.inf`.
- Activate the install menu. The files are copied and the registry of the PC is updated.
- When the copy process has finished, reboot the PC.

Note: The data flow rate from the MRR to the PC requires that the PC response time does not exceed certain limits. If the PC was configured and delivered by METEK (optional), meeting of this request is warranted. Any modern PC with medium performance is basically sufficient to run the Control Program without flaws, if there are not too many other tasks running simultaneously. Particularly virus scanning programs may slow down the PC below the minimum possible value. In that case the data records are corrupted. Check the integrity of recorded data by visual inspection or by some automated procedure.

### 6.2 Using the Control Program

---

After login to the operating system open a command line window and enter the command `MrrCtrl.exe`. The following dialogue window appears (The screenshots in this manual were taken from a Windows® 2000 system.):

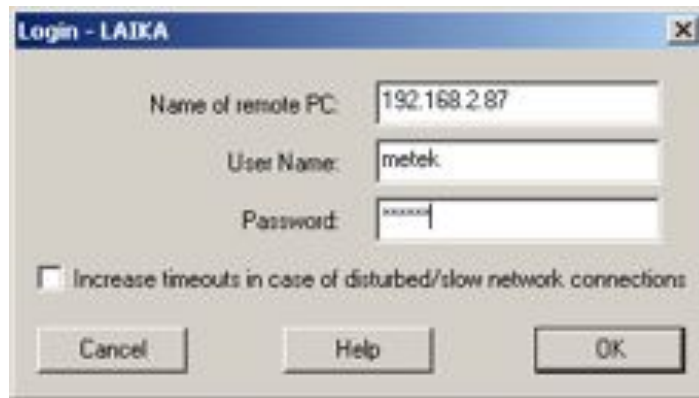

**Figure 9 Login Screen**

If you are sitting at the PC which is directly connected to the MRR-2 leave the entry at **Name of the Remote PC** empty (or type a period or the name of the local PC). If you are sitting at another PC, enter the name of that PC to which the MRR-2 is connected directly and where the communication service (`MrrCtrl.exe`) was started.

The User Name is generated automatically and the Password is usually not needed (see below for exceptions).

The **Password** entry field is useful if the remote computer is a member of another Windows domain, because in this case a connection can be built up only if a user name and the matching password is given. The user name is set automatically (see the header of the dialog window).

The network connection to the remote computer usually is a LAN- or a RAS connection. RAS connections using the public telephone net are mostly not very efficient, especially connections with mobile phone radio nets. Considering that, the login dialog provides the use of time-out-values which are adjusted to the maximum delay times for the responses from the remote PC. Using a direct LAN or a local login, this feature is not needed.

If the program was started by a command line input, the information concerning the login window can be handed over as a parameter. Example:

```
C:\METEK\MrrCtrl hostname secret /t
```

This entry would try to build a connection to a computer with the name `\\hostname`. The password is `secret`, the time-out-values are set for slow WAN connections (`/t`). The parameter `/t` is optional, the computer name and the password however must be given always. This is also valid for local logins (the password will not be checked).

If the connection to the communication service could be built up, the entire status of the MRR-2 is read out first. This can take some seconds, on RAS connections even some minutes.

Click the OK button

The MRR-2 status is read out which takes some seconds (in case of slow remote communication even some minutes). Then the Main Menu will appear.

## 6.2.1 Main Menu



**Figure 10 Main Menu**

The main menu shows buttons for the menus

<b><i>Control</i></b>	chapter 6.2.2 on page 20
<b><i>Output Parameters</i></b>	chapter 6.2.3 on page 20
<b><i>Device Parameters</i></b>	chapter 6.2.4 on page 23
<b><i>Parameter Sets</i></b>	chapter 6.2.5 on page 24
<b><i>System Status</i></b>	chapter 6.2.6 on page 27

You can leave the program with the ***Exit*** button.

The ***Help*** button provides a Windows conforming help text.

## 6.2.2 Control Commands Menu

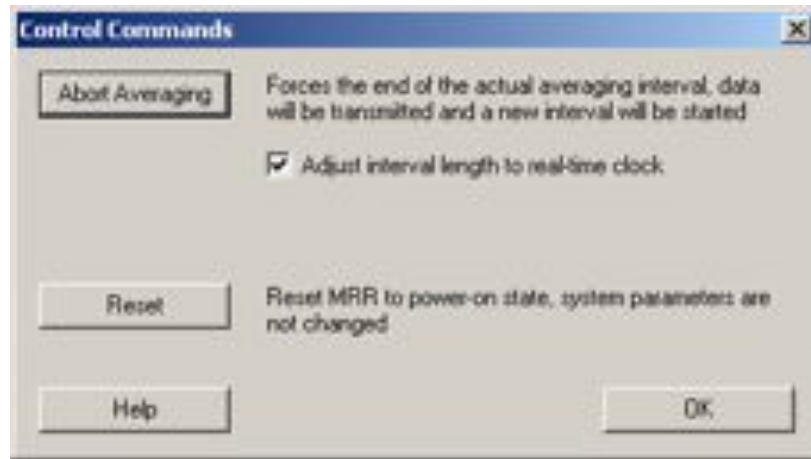

**Figure 11 Control Commands**

### **Abort Averaging**

The current averaging interval is stopped. Data, collected since the begin of the averaging interval, are processed and a new averaging interval is started regardless of elapsed averaging time.

### **Adjust interval length to real time clock**

This checkbox activates the synchronization of measuring intervals to the actual time of day. This means every output of averaged data will occur at 'round' times. Example:

If the measuring time has been set to 600 seconds, output will be generated at every full 10 min.

### **Reset**

Pressing this button will perform a reset of the RCPD firmware. There is no influence on the MRR-2 parameters. It has the same effect as an interruption of the power supply.

## 6.2.3 Output Parameters Menu



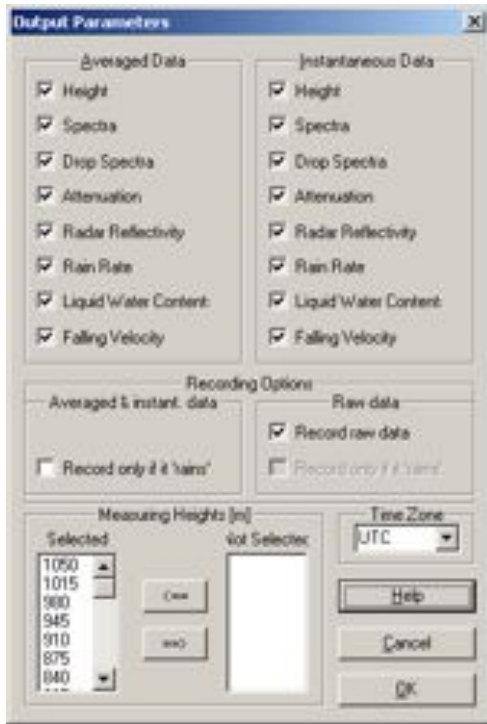

**Figure 12 Output Parameters**

The two upper panels shown in Figure 12 contain check boxes for configuring selections of *averaged data* and *instantaneous data* separately for recording. *Instantaneous data* are processed on the basis of one raw spectrum<sup>1</sup>. *Averaged Data* are processed on the basis of an average of multiple raw spectra, depending on the selected averaging time. The selectable variables are described in the table below.

<b>Selection of</b>	<b>causes the recording of</b>
<b><i>Height</i><sup>2</sup></b>	Measuring height above ground
<b><i>Spectra</i></b>	Spectral volume reflectivity
<b><i>Drop Spectra</i></b>	Drop diameter and number of drops per volume and diameter
<b><i>Attenuation</i></b>	Two way path integrated attenuation
<b><i>Radar Reflectivity</i></b>	Radar reflectivity factor and attenuated radar reflectivity factor
<b><i>Rain Rate</i></b>	Vertical volume flux of liquid water per unit area
<b><i>Liquid Water Content</i></b>	Mass of liquid water per volume
<b><i>Falling Velocity</i></b>	Doppler velocity (1. moment of the spectrum)

<sup>1</sup> Since the raw spectra and the instantaneous data represent already averages over 10 seconds, the term “instantaneous” must not be understood literally.

<sup>2</sup> The output variable *Height* should always be selected, as this facilitates further processing of recorded data.

## Recording Options

### Raw data

By checking “Record raw data” the raw spectra including metadata are written in addition to other selected data to a separate log-file. The path name of these log-files is defined by the parameters RawDataFile , RawDataPath.

### Conditional recording

By checking “Record only if it rains” no data are recorded, if the evaluation software does not detect precipitation in any measuring height during the measuring (averaging) interval. This condition can be activated separately for averaged/instantaneous data and raw data respectively.

### Measuring Height(s)

A subset of measuring heights can be selected for recording. This subset is used for both kinds of data output, instantaneous and averaged data. The selection of measuring heights for output is done with two lists containing the selected and unselected height steps. To move items (sets of height steps) between the lists they must be marked in the source list. The movement will be performed when the arrow button pointing to the other target list is pressed. (The *height resolution* (step-width) can be adjusted with the device parameters menu (see chapter 6.2.4 on page 23)).

### Time Zone

The time zone can be selected which is used for the time stamps of the recorded data.

All changes in the Output Parameters Menu become effective by clicking the “Ok” button. Then the corresponding commands are transmitted to the RCPD firmware. Clicking the “Cancel” button cancels all changes.

## 6.2.4 Device Parameters Menu

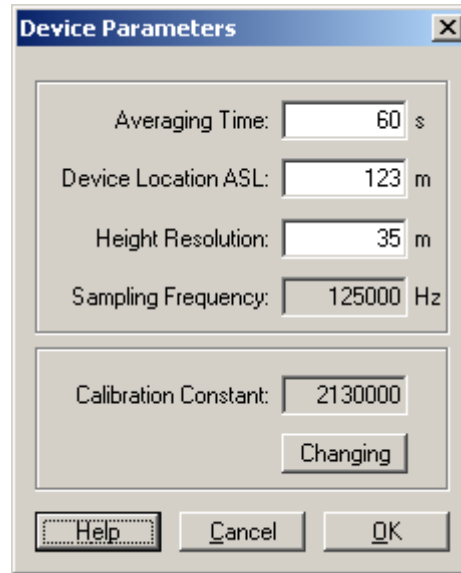

**Figure 13 Operation Parameters**

### **Averaging Time**

Here you define the averaging time for the *averaged data*.

The adjustable range is 10 .. 3600 s

After each averaging time, an *averaged data* set is generated and recorded and a new averaging interval starts. Instantaneous data are generated and recorded independently in 10 s time intervals within each averaging interval.

### **Device Location ASL**

Enter the height of the MRR-2 location above sea level.

The adjustable range is 0 ... 9999 m.

This parameter is used for the density correction of the fall speed versus drop size relation.

### **Height Resolution**

Enter the desired distance between adjacent measuring heights (step width).

The adjustable range is 10 - 1000 m. Typical values are 30 – 100 m.

The measuring heights are integer multiples of the height resolution. The maximum number of height steps is 31.

### **Sampling Frequency**

Number of samples per second of the analogue input signal of the MRR-2.  
This parameter can't be changed by the user.

### Calibration Constant

This constant is needed for converting the engineering units of the receiver signal (raw data) into physical units (instantaneous and averaged data). See Physical Basis for details. The calibration constant is factory set. Nevertheless it can be changed by the experienced user. Before a new calibration constant can be entered the “changing” button must be pressed. It should be only done, if there is clear evidence for a miss-calibration of the MRR. This can be inferred for example from rain rates measured with the MRR ( $R_{MRR}$ ) and a rain gauge ( $R_{RG}$ ) respectively. If  $C_{old}$  is the old calibration constant, the new calibration constant  $C_{new}$  can be calculated according

$$C_{new} = C_{old} \frac{R_{RG}}{R_{MRR}}$$

It should be kept in mind that comparisons of rain rates measured aloft with the MRR and a rain gauge are not straightforward due to the strong inhomogeneity of rain. MRR data should be taken from range gates not below the 3<sup>rd</sup> range gate, because approximations in the radar equation cause larger biases at lower range gates. On the other hand the measuring height should not exceed 200 m in order to keep attenuation effects small (they are only eliminated in case of correct calibration) and to keep the correlation with surface precipitation at a useful level. Further make sure that the MRR rain retrieval is not affected by the ice phase or melting processes. Strong winds should also be avoided since rain gauges tend to unreliable under such conditions.

### OK

All changes in the Device Parameters Menu become effective by clicking the “OK” button. Then the corresponding commands are transmitted to the RCPD firmware. Clicking the “Cancel” button cancels all changes.

## 6.2.5 Parameter Storage

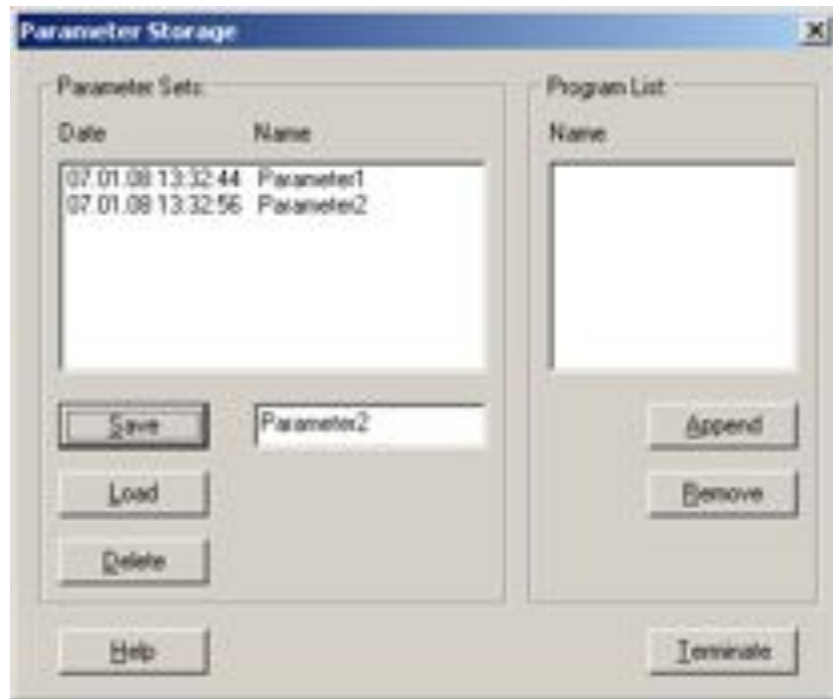

**Figure 14 Parameter Storage**

### Parameter Sets

The parameter memory of the MRR-2 is used for convenient saving and loading of complete parameter settings.

#### Saving a parameter set:

- Type a name in the field right of the **Save**-button or select a name of the Parameter Sets list.
- Click the **Save**-button.

#### Loading a parameter set:

- Type a name of the Parameter Sets list in the field right of the **Save**-button or select a name of the Parameter Sets list.
- Click the **Load**-button.
- 

#### Deleting a parameter set:

- Type a name of the Parameter Sets list in the field right of the **Save**-button or select a name of the Parameter Sets list.
- Click the **Delete**-button.

A parameter set consists of

- the device parameters (except calibration constant) and
- the selected output parameters

### **Program List**

Previously defined parameter sets can be added to a program list. All sets, which are included in this list, will be processed successively. This means every time the averaging interval has finished, the next entry will be loaded from the list. After reaching the end of this list, the program starts over with the first entry.

### **Creating a Program List**

- Select a parameter set in the Parameter Sets list
- Click the **Append** button. The parameter set is inserted in the empty Program List or added to the end of the non-empty Program List.

As soon as the Program List is not empty, it becomes active.

### **Removing entries from the Program List**

- Select the entry from the Program List
- Click the **Remove**-button

### **Note:**

1. Parameter sets, which appear in the Program List can neither be changed nor deleted.
2. The same parameter set name may appear at several places in the Program List.

## 6.2.6 Status messages and time-axis control

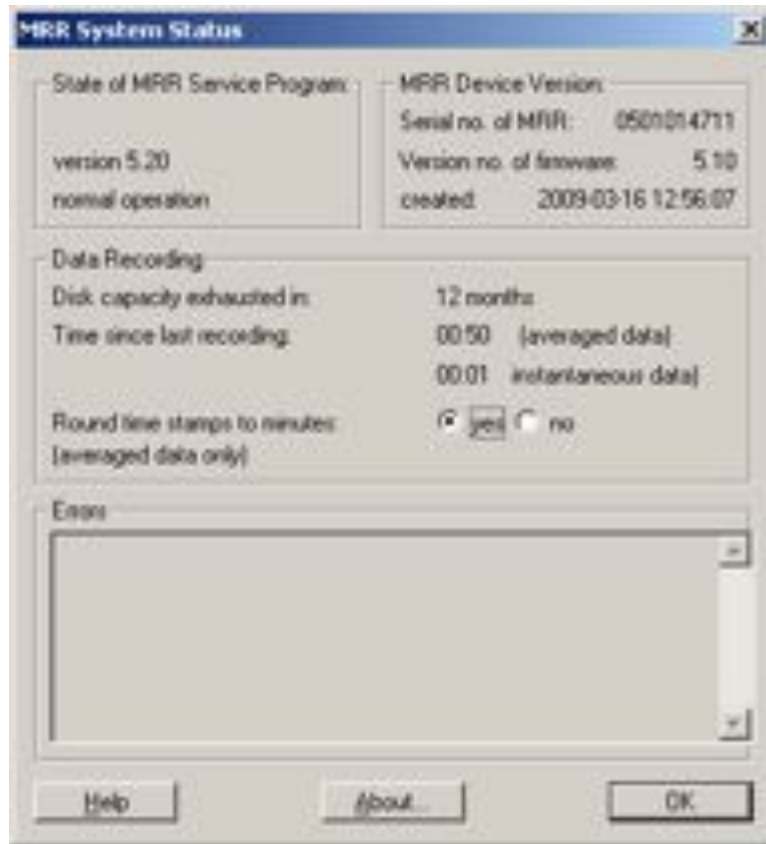

**Figure 15 System Status**

### **Sub-Panel: “State of the MRR Service Program”**

The version number of the MRR service program is shown.

The operation state is shown:

- *normal operation*  
No problems occurred.
- *erroneous operation*  
One component of the service could not be installed. Either a hardware error or a conflict between programs occurred (Example: Two programs attempt to access the same port.)

### **Sub-Panel: “MRR Device Version”**

The serial number, the firmware version number and the firmware creation date of the connected MRR are shown.

**Sub-Panel: “Data Recording”**

*Disk capacity exhausted in*                      The remaining time for data recording is shown. The calculation is based on the average sizes of the last received measuring protocol and the actual free disk space (Initially ??? appears until the first data set is stored).

*Time since last recording*                      The time elapsed, since the last averaged and instantaneous data sets were written to disk, is shown (Initially ??? appears until the first data set is stored).

*Round time stamps to minutes*                Time stamps are rounded to integer values. This can be useful under the following condition: If the "Adjust interval length to real time clock" (see chapter 6.2.2 **Control Commands Menu**) was selected, the time stamps should be integer multiples of 10 seconds, minutes or ten minutes. Nevertheless small deviations from these integers may occur due to variable processing time. If this is disturbing for subsequent data analysis programs, the recorded time stamps can be rounded. The selection *yes* or *no* is activated by pressing the *ok* button.

**Sub-Panel “Errors”**

This panel shows a list of errors which occurred during the measuring operation. Errors which occurred before the control program was started can be retrieved from the Windows® 2000- or Windows® XP-event log.



## About Button



**Figure 16** This panel appears after clicking the *About*-button

## 6.3 Instantaneous and averaged data

### 6.3.1 Format description

Instantaneous and averaged data are archived in two separate directory structures (see chapter 7.1.2 Data Recording on page 41). Optional recording of so called raw data, which represent the unprocessed measuring data of the MRR-2, is only useful for special purposes.

The data format is human readable ASCII text. Each data set consists of one line. The order of the data lines and the used identifiers are listed below:

Identifier	Meaning	Unit	Remark
MRR	<i>Header Line</i>	n.A.	
H	<i>Height</i>	m	
TF	<i>Transfer Function</i>	dimensionless	
Fnn	<i>Spectral Reflectivities</i>	dB	$10 \cdot \log \eta_{nn}$ with $\eta_{nn}$ in $\text{m}^{-1}$ $nn$ from $\min(h)$ to $\max(h)$ <sup>3</sup>
Dnn	<i>Drop Size</i>	mm	Center of size class
Nnn	<i>Spectral Drop Densities</i>	$\text{m}^{-3} \text{mm}^{-1}$	$N(D_{nn})$ <sup>3</sup>
PIA	<i>Path Integrated Attenuation</i>	dB	
Z	<i>Radar Reflectivity</i>	dBZ	$10 \log \left( \sum_{nn=\min(h)}^{nn=\max(h)} N(D_{nn}) D_{nn}^6 \right)$ $nn$ from $\min(h)$ to $\max(h)$
z	<i>Attenuated Radar Reflectivity</i>	dBZ	Z-PIA
RR	<i>Rain Rate</i>	$\text{mm h}^{-1}$	
LWC	<i>Liquid Water Contents</i>	$\text{g m}^{-3}$	
W	<i>Fall Velocity</i>	$\text{m s}^{-1}$	

<sup>1)</sup> See *MRR-Physical Basics* for details.

The measured data are displayed in lines following the header. For each measured variable there is one line starting with a 3-character identifier of the variable. Each line represents a profile of this variable, i.e. a function versus height. Each data entry is 7 characters wide. Height is running from left to right

<sup>3</sup> See *MRR-Physical Basics* for details.

in increments according to the chosen height resolution of the MRR. Invalid or not calculable values are coded as 7 consecutive space characters. Space characters—at the end of a line are omitted in order to save disk space. So lines can have different lengths although representing the same number of height steps.

### **MRR – Header Line**

*Entries common to instantaneous and averaged data:*

The header line marks the beginning of a data set. It starts with the identifying string "MRR", a space character and a date/time stamp.

The date/time stamp consists of 12 digits (format *YYMMDDhhmmss*), a single space character and the name of the time zone. This name starts with the string „UTC“ and is optionally followed by an offset value (format *±hh* or *±hhss*).

The end of the header line shows a data quality parameter consisting of the identifying string "MDQ", a single space character and a 3digit number between 0 and 100. It is the percentage of valid spectra collected during the averaging interval. Spectra can be invalid due to saturation of the AD converter – caused either by extreme precipitation or by some interference.

*Entries only in averaged data:*

Averaging time in seconds ("AVE"), height resolution in meters ("STP"), height of the ground level above sea level in meters ("ASL"), sampling rate ("SMP") of the RADAR signal in the time domain (unit: Hz), parameters for the automatic noise level adjustment ("NF0" and "NF1" without unit), version number of the MRR Service ("SVS"), version number of the MRR firmware ("DVS"), serial number of the MRR ("DSN") and the calibration constant ("CC").

Each of the parameters in the header line starts with a delimiting space character, the 3-character identifier as shown above in the parentheses and a field of 6 characters for the numerical value (except of the serial number, which can consist of up to 10 numeric characters between 0 and 9).

Example (Each entry of the header line is shown in a separate line of the table) :

MRR*090612040200 UTC	The header line dates from June 12 <sup>th</sup> , 2009, 4:02 AM, UTC.
AVE***60	Averaging time is 60 seconds.
STP***35	Height resolution is 35 meters.
ASL***147	The radar is sited 147 meters above sea level.
SMP*125e3	Sampling rate is 125,000 Hz.
NF0*1.000	Noise level 0 set to 1.000 (used only in older versions).
NF1*0.000	Noise level 1 set to 0.000 (used only in older versions).
SVS*5.20	Version number of the MRR Service is 5.20.
DVS*5.10	Version number of the MRR firmware is 5.10.
DSN*020704	Serial number of the MRR is 020704.
CC*2066000	Calibration constant is 2066000.
MDQ*100	Percentage of valid spectra is 100.

## H - Height

Argument of the following data profiles corresponding to the settings described in chapter 6.2.3, page 20, and chapter 6.2.4, page 23. The units are meters above the radar system.

## TF - Transfer Function

To each height step a value of the Transfer Function is assigned by which raw data are divided.

## Fnn with nn from 0 to 63 - FFT Spectra

Each line represents a profile of spectral reflectivity corresponding to the spectral bin *nn*. As **Fnn** is corrected for the receiver noise floor negative values can occur, if the signal to noise ratio is low. These entries cannot be presented in the logarithmic domain and are replaced by space characters.

## Dnn with nn from min(h) to max(h) - Drop Sizes

The drop size is described by the diameter of an equivolumic sphere. The spectral bins of drop numbers are of variable width in the size domain (in contrast with spectral bins in the frequency- and velocity-domain). In addition, the

widths of the size bins are slightly height dependent. Therefore the assignment of frequency-bin-index  $nn$  to diameter  $D$  is listed explicitly for each bin and height. The center of each size class is displayed.

### **Nnn with $nn$ from $\min(h)$ to $\max(h)$ - Spectral Drop Densities**

With the knowledge of the frequency of the Doppler-shift the calculation of the corresponding drop fall velocity is possible (equation 1.4.3.2 in MRR Physical Basics). Thus each FFT-line stands for a drop size interval. Chapter 2 in the Physical Basics shows how to derive from the received spectral power the number of drops for this drop size class, and finally – by division through the variable class width – the spectral drop densities.

Only a sub-set of all 64 spectral bins is considered for the calculation. The lower ( $\min(h)$ ) and upper limit ( $\max(h)$ ) depends on the height as described in MRR Physical Basics (Fig. 7).

In case of negative values of  $F_{nn}$  negative drop number densities are calculated. Although they have no physical meaning they are retained in order to avoid statistical biases.

### **PIA - Path Integrated Attenuation<sup>1)</sup>**

The two-way Path integrated attenuation by rain drops is calculated as described in chapter 3.2 MRR-Physical Basis and is used for correction of  $N_{nn}$ ,  $Z$ ,  $RR$  and  $LWC$ .

### **$z$ - Attenuated Radar Reflectivity<sup>2)</sup>**

$z$  is the radar reflectivity factor (see chapter 3.1 MRR-Physical Basics) without attenuation correction

### **$Z$ - Radar Reflectivity<sup>2)</sup>**

$Z$  is the radar reflectivity factor (see chapter 3.1 MRR-Physical Basics)

### **$RR$ - Rain Rate<sup>2)</sup>**

$RR$  is the rain rate (see chapter 3.3 MRR-Physical Basics)

**LWC - Liquid Water Content<sup>2)</sup>**

LWC is the liquid water content (see equation 3.2.1 MRR-Physical Basics)

*<sup>2)</sup> In case of low signal to noise ratio negative values can occur. Although they have no physical meaning they are retained in order to avoid statistical biases.*

**W - Fall Velocity**

W is the characteristic falling velocity.

(First Moment of the Doppler spectrum, see chapter 3.4 MRR-Physical Basics).

The width of velocity-bins can be derived from the maximum number of height steps, the sampling rate (as shown in the header line) and the wave length of the RADAR signal. 32 height steps and 64 lines per step are calculated. For a sampling frequency of 125 kHz and a transmit frequency of 24.15 GHz, the resolution of the fall velocity can be calculated as:

$$\frac{125 \text{ kHz}}{2} \frac{1}{32 \cdot 64} \frac{299700 \text{ km/s}}{2 \cdot 24 \text{ GHz}} = 0.1905 \text{ m/s}$$







N34	15543	19429	18430	15880	15100	16759	15610	13544	13375	14668	16884	18871	18722	18590	19172	17529	20454	20027	17849	17282	15318	15391	16430	23729	35545	46676	43087	31116	15240	4622.4	1196.3	
N35	11074	14746	13021	11318	11080	11857	10535	9071.8	9153.5	10891	12100	13423	13959	13631	13374	12554	14989	14600	13282	13155	11733	13308	14872	18890	24295	28910	25386	16667	7517.4	1769.8	372.01	
N36	8063.7	10718	8927.8	7966.0	7954.2	8413.8	7584.7	6429.2	6668.3	7912.6	8156.4	8572.4	9241.6	9262.2	9187.0	8380.0	9491.1	9687.6	9774.1	9585.0	8641.0	10461	12281	14376	15828	15629	12579	7542.3	3299.7	699.22	127.95	
N37	5579.9	7232.0	5896.5	5342.4	5529.4	6050.6	5548.5	4679.9	4724.6	5237.0	5312.6	5556.1	5978.6	5945.9	6001.2	5351.7	5813.2	6361.6	6982.7	6806.1	6566.6	7816.2	8969.7	9791.1	10116	8644.9	5594.9	2947.6	1201.5	236.46	50.288	
N38	3660.6	4631.9	3782.0	3554.0	3882.1	4301.2	3788.2	3094.7	3073.3	3388.5	3572.4	3826.3	4115.9	3848.7	3753.9	3401.1	3693.0	4212.3	4742.4	4694.6	4822.6	5578.4	6223.4	6570.3	6224.6	4805.3	2510.5	1149.9	428.02	73.016	40.260	
N39	2451.6	3052.0	2462.6	2454.8	2701.9	2879.9	2516.2	1986.3	1970.7	2224.8	2389.8	2510.6	2621.3	2340.3	2308.5	2145.4	2363.8	2776.2	3040.2	2991.0	3206.6	3590.5	4066.8	4184.1	3400.7	2300.2	1089.4	447.38	153.45	23.465	45.138	
N40	1619.3	2074.6	1583.4	1582.6	1763.5	1834.0	1574.2	1260.2	1294.3	1402.1	1458.3	1450.0	1468.7	1288.6	1363.3	1331.0	1495.8	1722.1	1838.6	1847.8	2074.7	2231.3	2468.2	2294.7	1631.5	949.15	424.41	166.03	51.607	6.7670	45.100	
N41	982.38	1326.3	973.26	959.24	1050.9	1068.5	858.33	744.14	829.82	857.60	842.94	812.12	831.79	723.97	797.48	805.01	917.07	1012.8	1109.3	1210.2	1333.5	1407.9	1414.7	1116.5	712.05	366.94	154.27	62.599	17.781	2.8902	43.531	
N42	559.59	801.97	590.94	560.59	570.14	570.07	441.00	428.44	513.44	509.34	483.11	472.63	466.78	408.14	449.80	443.00	503.02	542.48	648.21	783.12	818.78	829.53	748.08	508.35	280.57	132.16	51.527	21.089	5.7216	1.2082	41.131	
N43	311.72	452.26	341.63	311.89	298.49	296.60	243.05	266.12	315.43	285.84	267.08	259.91	236.88	207.13	222.80	211.03	240.93	268.09	351.68	453.51	472.69	455.83	358.53	206.85	103.39	45.136	16.576	5.5499	1.1879	0.9027	36.637	
N44	169.68	239.35	178.44	164.85	152.13	148.30	137.29	172.38	192.97	159.46	138.54	126.42	111.82	93.173	92.717	91.467	109.10	127.54	181.10	233.85	246.11	239.27	169.73	76.829	36.747	15.236	5.1847	1.0163	0.1858	1.2911	32.235	
N45	81.786	121.41	84.666	81.660	79.681	78.907	77.345	103.17	113.45	92.542	68.828	57.519	50.597	37.522	33.149	36.609	47.387	54.895	82.849	112.99	119.13	115.14	76.344	28.340	11.652	4.4790	1.2523	-0.1501	0.1087	1.4566	27.688	
N46	34.401	57.447	38.938	39.926	41.450	43.409	45.297	54.983	60.493	52.144	33.413	25.366	20.018	12.808	11.334	13.548	17.845	20.532	31.125	48.032	53.157	48.112	29.404	9.4621	3.2046	1.0200	0.1508	-0.1471	0.2992	1.2458	21.402	
N47	14.599	25.105	17.415	18.311	18.017	21.264	26.064	29.209	30.549	26.836	16.089	11.018	7.6411	4.1295	3.6462	4.5463	5.7951	6.7475	9.5651	16.130	19.956	17.000	9.3864	2.6096	0.7768	0.2122	0.0214	-0.0118	0.3312	0.8860	14.571	
N48	6.0655	10.083	6.7792	6.7683	6.5345	9.1416	12.917	15.288	15.165	12.710	7.4520	4.6330	3.0609	1.3756	0.9208	1.3419	1.6967	1.8734	2.5597	4.3964	6.1000	4.8768	2.2767	0.5247	0.0722	-0.0227	9.6e-4	-0.0267	0.2702	0.6419	8.2911	
N49	2.5061	3.6136	2.2706	1.9711	2.0213	3.5677	5.5743	7.8399	7.7926	5.9892	3.3414	1.7142	0.9998	0.3713	0.1577	0.3096	0.3850	0.3988	0.6132	1.0605	1.5677	1.1634	0.4705	0.1001	-0.0409	-0.0489	0.0142	0.0276	0.2706	0.4230	4.0321	
N50																0.0510	0.0522	0.0533	0.1262	0.2087	0.3256	0.2438	0.1037	0.0316	0.0116	0.0055	0.0252	0.0680	0.2527	0.3298	1.8604	
N51																																0.7945
PIA	0.000	0.028	0.054	0.076	0.097	0.120	0.143	0.162	0.182	0.204	0.226	0.248	0.270	0.292	0.315	0.334	0.354	0.374	0.395	0.414	0.433	0.453	0.475	0.500	0.528	0.565	0.610	0.667	0.743	0.833	0.939	
Z	32.52	33.54	32.65	32.07	31.98	32.17	31.91	31.51	31.60	31.57	31.22	31.08	30.90	30.59	30.51	30.04	30.24	30.28	30.36	30.40	30.31	30.37	30.39	30.55	30.90	31.57	32.08	32.73	33.37	33.36	33.33	
Z	32.52	33.56	32.69	32.14	32.07	32.29	32.05	31.67	31.77	31.77	31.43	31.32	31.16	30.87	30.82	30.37	30.59	30.65	30.75	30.82	30.75	30.83	30.87	31.06	31.44	32.15	32.69	33.40	34.10	34.18	34.25	
RR	2.93	3.25	3.09	2.58	2.52	2.71	2.69	2.31	2.41	2.68	2.69	2.72	2.74	2.79	2.81	2.49	2.47	2.42	2.41	2.30	2.24	2.35	2.62	3.00	3.46	4.53	5.96	8.08	12.16	16.29	20.79	
LWC	0.17	0.18	0.17	0.14	0.14	0.15	0.16	0.14	0.14	0.16	0.17	0.17	0.18	0.19	0.17	0.17	0.18	0.19	0.18	0.18	0.20	0.22	0.23	0.25	0.31	0.40	0.50	0.76	1.07	1.49		
W	6.57	6.73	6.57	6.66	6.68	6.81	6.84	6.95	6.90	6.72	6.57	6.51	6.53	6.42	6.45	6.48	6.58	6.68	6.83	6.99	7.09	7.10	7.00	6.77	6.50	6.20	5.88	5.53	5.11	4.61	4.16	

## 6.4 Raw data

---

### 6.4.1 Format Description

Each data block in a **raw data** file begins with a header line which contains the date, the time and the time zone of the following data block. This line is preceded by the letter T and a colon (T means time). The format of the date/time stamp is YYMMDDhhmmss, which means year, month, day, hour, minute and second with 2 digits each. Date, time and time zone are separated by a space character. The header line is supplemented with the version number of the MRR firmware (following the identifier DVS), the serial number ( of the MRR (following the identifier DSN), the calibration constant of the MRR (following the identifier CC) and the percentage of valid spectra (following the identifier MDQ).

The next data lines contains the measuring heights. It begins with the capital letter M, a colon, the small letter h, two space characters, and an equals sign (M means measured value, h means height). The following numbers (9 digits decimal each) represent the measuring heights in meters.

The height line is followed by the line of the transfer function. It starts with the capital character M, a colon, the capital letters T and F and one space character. The rest of that line represents the values of the transfer function for each height step ( 9 digits decimal each).

The line of the transfer function is followed by 64 data lines. Each one starts with the capital character M, a colon, the small letter f, and a 2-digit number of the spectra line (0 to 63). The rest of these lines represent the received spectral signal power in engineering units for each height step (9 digits decimal each).

The raw spectra include the receiver noise floor.

### 6.4.2 Example

```

T:090612024311 UTC DWB 5.10 DSN 020704 CC 2066000 NDO 100
Mch = 0 35 70 105 140 175 210 245 280 315 350 385 420 455 490 525 560 595 630 665 700 735 770 805 840 875 910 945 980 1015 1050 1085
MTP = 0.005292 0.011523 0.041975 0.098986 0.175883 0.254184 0.340119 0.425514 0.532373 0.603018 0.675220 0.756116 0.794239 0.831626 0.877778 0.891358 1.000000 0.968112 0.924280 0.893381 0.890398 0.875857 0.853772 0.843347 0.834568 0.780658 0.774897 0.752401 0.680260 0.640604 0.422497
M100= 4798 2205 1666 126 22 20 20 20 19 18 16 15 18 15 12 10 11 10 7 6 6 4
M101= 2780 2272 107 33 19 20 25 23 22 20 22 28 29 27 22 18 18 20 18 21 25 21 15 14 12 12 12 11 8 7 5
M102= 541 246 33 20 22 22 27 27 26 25 26 32 34 32 28 23 25 25 24 28 30 25 17 17 16 13 13 14 15 10 8 6
M103= 39 22 17 20 25 24 27 28 28 26 26 31 35 33 28 24 29 28 25 27 28 25 19 21 19 14 14 14 13 11 8 6
M104= 4 9 18 22 25 24 27 30 29 26 24 26 30 27 24 27 34 30 25 24 25 24 20 22 20 14 15 14 12 12 9 6
M105= 3 9 19 26 27 24 26 30 29 31 26 21 25 22 20 30 36 31 26 23 23 22 18 19 17 12 13 13 11 12 11 7
M106= 3 9 20 32 32 24 24 28 30 33 24 22 27 24 21 30 35 30 27 23 23 19 18 16 14 11 11 11 12 13 12 7
M107= 3 9 21 38 38 27 24 25 27 30 27 25 30 27 24 31 33 31 29 26 24 20 20 16 13 11 13 13 11 12 12 7
M108= 3 10 23 19 49 32 36 34 22 29 20 27 29 30 31 34 32 31 32 38 25 22 24 16 13 13 16 15 10 10 11 6
M109= 4 11 28 61 54 36 29 25 24 30 33 28 29 35 38 35 36 33 32 27 24 21 23 15 15 17 17 15 10 9 10 6
M110= 5 13 24 30 56 38 34 30 32 32 34 33 33 43 46 38 41 37 30 25 24 19 18 17 20 20 17 14 12 12 9 5
M111= 4 16 44 85 60 39 38 35 37 34 35 39 36 47 54 48 47 39 30 24 22 19 20 21 26 20 16 14 13 14 8 4
M112= 5 18 55 107 71 48 47 42 42 41 40 43 37 46 57 54 55 45 30 24 21 20 20 23 29 21 16 15 14 13 7 4
M113= 7 19 65 137 93 75 60 46 47 52 51 47 38 47 56 52 61 52 34 23 23 24 21 29 33 28 21 18 17 13 6 5
M114= 9 23 84 198 141 127 88 49 53 61 56 48 39 53 62 59 68 60 42 29 28 29 26 37 40 38 31 24 21 15 9 6
M115= 12 34 139 329 220 182 124 60 62 75 64 54 45 65 80 78 80 71 52 39 34 35 43 47 49 41 36 29 24 17 12 7
M116= 15 52 236 522 336 215 136 69 74 88 74 65 59 78 92 93 91 84 63 49 42 46 45 64 57 42 37 31 28 19 12 8
M117= 24 75 225 698 485 275 150 81 85 90 85 79 83 89 100 101 101 102 83 58 54 61 78 72 61 48 41 33 31 22 12 7
M118= 48 120 374 710 569 364 199 116 115 112 105 94 106 132 127 108 112 122 125 106 71 68 70 63 48 42 32 30 23 12 7
M119= 98 235 526 747 595 418 242 166 178 168 133 115 126 152 157 157 123 132 157 136 101 88 78 71 73 63 44 38 29 27 25 15 9
M120= 177 377 803 915 652 452 288 237 240 236 188 149 155 169 192 159 168 182 170 139 115 101 76 65 62 43 36 29 27 29 19 11
M121= 290 582 1054 1084 739 488 303 257 276 295 242 195 187 266 243 201 190 179 179 150 125 121 96 67 71 52 40 36 36 38 24 12
M122= 492 873 1270 1406 1049 557 352 281 393 305 310 266 234 259 267 222 207 171 152 125 117 124 111 93 91 66 50 47 49 48 31 16
M123= 814 1437 1629 1947 1531 666 418 340 355 315 349 369 345 329 261 225 224 178 142 109 122 129 116 125 114 88 80 64 62 61 40 22
M124= 1103 2015 2193 2970 2137 816 526 473 506 421 309 486 480 405 278 248 249 225 176 140 141 130 151 128 147 131 124 91 88 88 55 23
M125= 1215 2304 3049 4586 3032 973 722 714 711 661 829 608 523 405 287 289 322 323 257 222 179 161 194 220 207 195 176 129 133 130 81 48
M126= 1202 2861 4088 5698 3567 1012 867 906 893 733 513 352 284 358 464 482 382 369 262 252 330 337 297 270 243 192 179 162 106 61
M127= 1692 3945 4978 5726 3427 893 775 923 1093 1218 1081 731 502 394 351 445 628 732 577 586 405 437 514 481 423 367 299 263 248 200 124 79
M128= 3428 4611 6013 6285 3599 883 731 1024 1164 1418 1153 719 516 513 543 565 807 1059 830 791 549 632 668 614 557 452 349 317 349 282 146 97
M129= 6270 5873 8179 7200 3957 1140 965 1395 1737 2114 1536 855 643 639 762 756 1113 1595 1225 983 714 817 814 673 573 450 403 404 446 355 166 105
M130= 9754 9622 11394 7165 4522 2175 1524 2165 2896 2947 1902 1066 893 830 948 934 1443 2426 2014 1453 1080 1073 1003 695 466 385 204 517 369 204 128
M131= 13520 15729 15559 7632 6648 4740 2698 3354 4341 3500 2201 1344 1043 1018 1095 1059 880 2799 3242 2339 1587 1295 1095 675 317 315 525 557 425 331 251 187
M132= 15274 23192 21814 10788 11365 8977 5307 4776 5807 3976 2625 1708 1151 1200 1387 1756 2922 3657 4268 3481 2313 1489 805 361 207 414 461 340 289 266 227
M133= 13520 26471 25550 15241 18222 15980 10203 7315 7471 4865 3160 2005 1326 1568 2126 3210 4680 4528 4170 3876 2487 1273 441 202 62 92 211 307 320 276 245 176
M134= 9754 21874 22408 21097 23022 19392 16311 11855 11468 7592 4160 2636 2145 2913 2740 4692 5860 4499 2363 2929 1955 825 194 64 26 34 99 225 224 273 218 116
M135= 6270 15310 16602 15558 19843 18169 19653 18327 16854 11037 5469 4241 4229 5146 5376 5022 4785 3691 2351 1622 952 415 84 22 17 18 56 191 289 237 211 110
M136= 3428 9683 12461 12216 15818 13796 16298 18613 17631 10864 6094 6075 6527 6463 5080 3520 2864 6297 1243 674 375 171 40 15 15 16 36 163 246 176 178 103
M137= 1692 3945 4978 5726 3427 893 775 923 1093 1218 1081 731 502 394 351 445 628 732 577 586 405 437 514 481 423 367 299 263 248 200 124 79
M138= 1202 4727 11416 11332 6377 3700 4043 6282 5638 4052 4899 5560 6861 6584 2461 776 450 449 161 64 42 31 19 16 16 18 27 87 93 64 53 32
M139= 1215 6282 13578 12064 4531 1280 1280 1967 1806 1531 1950 2962 3602 2693 1137 307 172 65 28 22 22 18 14 15 17 19 37 35 25 21 16 7
M140= 1103 4033 10911 10304 2914 545 423 572 558 463 597 958 1075 770 369 128 84 80 33 19 16 18 18 13 15 18 17 17 15 14 10 8
M141= 814 3225 9611 8782 2958 260 208 227 185 151 155 230 224 179 115 60 50 38 23 20 16 17 17 13 15 18 16 15 16 14 11 9
M142= 492 2421 7508 7183 1576 130 97 79 54 65 76 66 62 51 37 34 24 22 20 19 18 17 14 14 14 15 16 14 13 14 12 12 8
M143= 290 1436 4351 4426 1007 58 41 42 38 38 41 39 36 41 39 25 21 23 21 21 21 20 18 17 14 16 15 15 13 12 12 12 7
M144= 177 675 2171 2315 502 33 25 28 32 33 33 26 26 25 23 21 22 22 20 19 16 16 16 13 11 11 11 13 14 8
M145= 98 318 1386 1407 254 30 24 24 31 31 27 21 22 27 26 24 23 20 19 22 24 23 20 20 15 14 14 13 12 11 14 12 7
M146= 48 149 828 804 125 27 23 21 27 29 25 22 23 23 24 25 23 18 18 23 24 23 18 18 13 11 12 14 12 13 11 7
M147= 24 60 332 325 67 25 22 19 25 29 25 24 26 25 27 27 26 22 19 25 25 21 17 16 12 11 12 14 13 11 11 7
M148= 15 21 96 101 35 27 24 19 22 29 26 25 28 27 30 27 25 23 19 23 23 19 15 15 12 11 13 14 13 10 10 8
M149= 12 10 38 23 27 25 18 20 28 24 21 25 25 25 21 19 18 19 22 21 19 16 16 12 10 12 14 13 10 9 7
M150= 9 8 19 24 22 26 23 20 24 29 25 19 21 20 19 18 16 17 20 23 22 21 18 17 13 9 11 14 14 11 10 7
M151= 7 7 14 22 26 27 23 22 27 31 27 18 21 20 18 18 17 20 25 23 21 20 16 14 13 14 12 14 12 11 11 6
M152= 5 7 12 20 27 28 26 27 28 31 28 20 23 24 21 18 18 14 19 26 22 20 20 16 13 11 11 13 13 12 13 13 7
M153= 4 6 11 17 24 26 26 28 29 33 29 26 27 24 20 19 20 14 19 23 22 20 18 16 14 13 13 14 13 14 13 8
M154= 5 8 13 19 24 23 24 26 30 33 31 30 27 22 20 22 23 17 18 20 20 20 18 16 16 15 15 14 15 14 10 8
M155= 4 10 15 21 26 23 23 26 28 30 33 32 25 20 22 25 25 20 20 19 17 19 18 16 16 13 14 14 13 12 9 6
M156= 3 9 15 21 25 22 22 25 32 34 27 22 22 25 24 24 21 23 24 21 18 19 14 14 17 17 14 15 12 11 10 6
M157= 3 10 19 25 24 21 22 20 21 24 31 35 31 26 22 22 24 22 26 24 20 19 14 13 16 17 17 14 14 13 10 9 6
M158= 3 11 24 30 26 22 23 23 22 22 28 28 30 29 22 24 24 26 25 21 17 14 16 23 17 14 15 17 12 9 8 6
M159= 3 10 24 31 26 23 23 25 24 20 25 23 26 29 21 18 21 21 22 24 24 21 17 15 17 18 18 15 16 12 10 8 6
M160= 4 9 21 28 25 22 21 26 26 21 25 24 25 28 21 21 21 20 20 20 20 19 17 16 18 17 17 16 15 15 10 10 6
M161= 39 25 18 24 24 20 18 21 29 25 27 27 22 23 20 18 18 16 17 15 10 10 11 10 11 10 10 10 10 10 10 6
M162= 541 254 29 20 24 21 18 24 30 28 22 24 29 28 22 22 21 19 19 18 16 15 16 16 17 16 18 14 10 11 10 6
M163= 2780 1279 95 32 23 21 18 22 24 23 19 23 27 27 21 18 18 19 18 15 15 14 14 14 14 12 12 14 11 9 10 6 4

```

## 6.5 Removing of the Software

If you want to remove the program from your PC you must be logged in as administrator. If still active you must stop the MRR-2 data-, error- & communication service using the services program in the program group control panel/Administrative Tools.

Then activate the folder software, select the entry METEK MRR Software and press the button Add/Remove. Finally you must manually remove the empty directory (C:\METEK) and possibly some data files and directories.

## 7 Detailed description of the MRR-2 control program

---

The MRR-2 generates Doppler spectra at 31 height ranges. The data processing is performed by a DSP which is located in the Radar Control and Processing Device (RCPD) at the antenna. The measured data are transmitted by a serial RS-232 port. This port is also used for the device control. If the MRR-2 is connected to a PC, the control, the calculation of further values, and the recording of the data can be done with the MRR-2-control program described below.

The software is divided into two components :

- Communication-, Data-, and Error- Service (CDES)
- Control Program User Interface (CPUI)

CDES communicates directly with the connected MRR-2, and CPUI performs the operational control of the MRR-2 using CDES. By means of this the user can interrogate or change the system status in a comfortable way.

### Windows® Service Programs

Service programs are software components, which are started automatically when the machine is turned on and the operating system boots. They offer their 'services' e.g. control functions and data to other programs. The management of those programs must be provided by the operating system. The starting of a service program needs no manual operation. Only take care that the corresponding service is not deactivated.

Various details of the usage of services depend on the operating system. For this reason the used operating system must be Windows® 2000 or XP. (Windows® Vista and Windows 7 are not supported).

## 7.1 Communication-, Data-, and Error-Service (CDES)

---

### 7.1.1 Communication Service

This service is needed for the communication between the control program user interface (CPUI) and the control port of the MRR-2, which is implemented as a serial interface. With CDES the system settings of the MRR-2 can be retrieved and any changes entered by the user are translated to the corresponding commands and transmitted to the MRR-2. (Factory setting of the serial port of the MRR-2 is 57600 baud, 8 bit, no parity, XON/XOFF handshake protocol.)

### 7.1.2 Data Recording

The second function of CDES is the recording of the “averaged” or “instantaneous” measured data of the MRR-2. The data is ASCII formatted, so that it is directly readable.

CDES creates one file each day, whose name is constructed from the actual month, the day (2 characters each) and an additional extension. The boundary between two days is defined as 0:00 (selected time zone including UTC). The file name extension is .MRR .

All files of a month are stored in a separate directory which will be created automatically if it is not already existing. The names of the directories are constructed from the actual year (4 digits) and the respective month (2 digits).

The path names for the data registration and the port settings may be changed with the MS registry editor regedit.exe at the key

```
HKEY_LOCAL_MACHINE\
  System\
    CurrentControlSet\
      Services\
        MrrSrvc\
          Parameters
```

The variables of this key are shown with their default settings. Change the underlined values, if necessary :

Port	REG_SZ	<u>COM2</u>
BaudRate	REG_DWORD	<u>57600</u>
AveragedDataFile	REG_EXPAND_SZ	<u>%MetekRoot%\ActData\Data%s</u>
AveragedDataPath	REG_EXPAND_SZ	<u>%MetekRoot%\Data</u>
InstantaneousDataFile	REG_EXPAND_SZ	<u>%MetekRoot%\ActData\InstData%s</u>
InstantaneousDataPath	REG_EXPAND_SZ	<u>%MetekRoot%\InstData</u>

The common root directory is defined by the environmental variable  
MetekRoot

It also can be changed with the registry editor at the following key :

```
HKEY_LOCAL_MACHINE\
  System\
    CurrentControlSet\
      Control\
        Session Manager\
          Environment
```

The variable is :

```
MetekRoot          REG_SZ          C:\METEK
```

The default settings are :

```
C:\METEK\Data      for averaged data
C:\METEK\ActData   for actual data( raw, instantaneous and averaged)
C:\METEK\Instdata  for instantaneous data
C:\METEK\Rawdata   for raw data,
                   not processed, only for testing purposes
C:\METEK           as the common root directory
```

The file C:\METEK\Data\200506\0611.MRR e.g. would contain the averaged data from June, 11<sup>th</sup> of 2005.

### 7.1.3 Error Protocol

The third function of CDES is the recording of all error messages which are caused by the operation of the MRR-2 (except messages which are generated from user input errors).

The error recording is done by the event logging function of the operation system. At the item application you find a chronologically sorted list of error messages, which occurred during the operation. Use the Windows event viewer to look at the messages or to store them in other formats. You also can define, how the system shall act if more than the storable number of errors occur. The event viewer is located in the program group Programs/Administrative Tools.

## 7.2 Control Program User Interface (CPUI)

CPUI provides the user access to the MRR-2 through CDES. The correct installation and the automatic start of the service program are required for a successful start of CPUI. CPUI allows controlling the MRR-2 also by PCs which are not connected directly to the MRR-2.

It is only necessary that there is a network connection to that PC, on which CDES was started. This network connection may be either a local connection (ethernet) or a remote access connection (RAS) which is built up using the public telephone. (Make sure that you have purchased the required number of program licenses.)

For this remote operation a login at the remote CDES is necessary when you start the program (e.g. by a mouse click on a program icon you created before, or by the command line `C:\METEK\MrrCtrl`). This ensures that only one user is accessing the MRR-2.

There are no special network installations needed, because no network protocol dependent functions are used between the service and the user interface.

The following picture shows an example for a remote access, where the network connection is performed by a RAS connection. The communication of the user interface on PC #2 with the MRR-2 uses the network and the communication service program on PC #1. The data recording and the event logging is executed on PC #1 which is connected directly to the MRR-2:

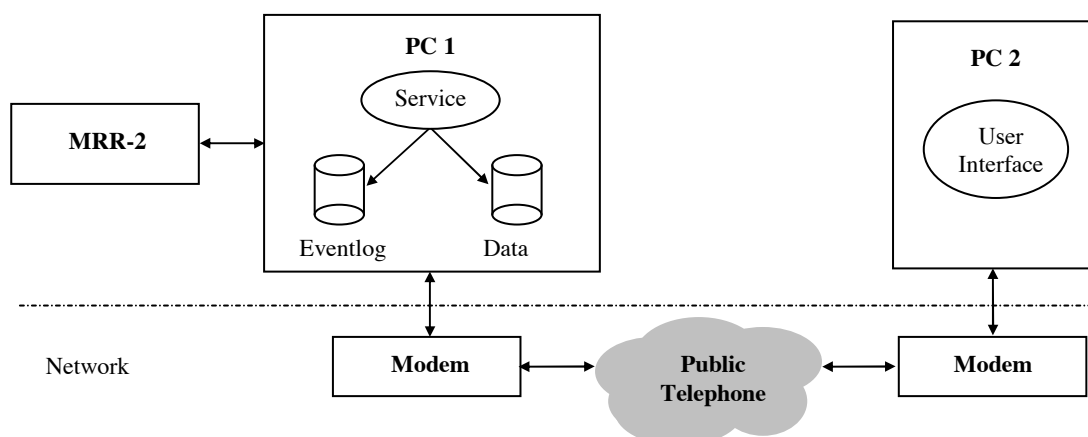

**Figure 17 Remote Acces**

The software is supplied on a CD-ROM with the following files:

MrrSrvc.exe	the service program
MrrCtrl.exe	control program (GUI)
Messages.dll	used for error messaging
MFC71.dll	used for runtime environment
msvcr71.dll	used for runtime environment
MrrXXXXXX.inf	installation file (XXXXXX stands for the serial number of the MRR)
MrrCtrl_D.hlp	help file German
MrrCtrl_E.hlp	help file English
MrrCtrl_D.cnt	help file German
MrrCtrl_E.cnt	help file English
MrrView.bat	
sbsize.exe	
setcolor.exe	
gzip.exe	data compression tool
tail.exe	data viewer



Figure 18 Directory Listing of the Installation CD-ROM

After installation of the MRR software the port settings may be changed with the MS registry editor regedit.exe at the key

```
HKEY_LOCAL_MACHINE\
  System\
    CurrentControlSet\
      Services\
        MrrSrvc\
          Parameters
```



The port variables of this key are shown with their default settings. Change the underlined values, if necessary :

Port	REG_SZ	<u>COM2</u>
BaudRate	REG_DWORD	<u>57600</u>

(You must be logged in with administration rights to change Windows® Registry parameters)

Every time when you change one ore more MRR parameters in the Windows® Registry you have to restart the MRR service because these parameters are only read from the Registry when the service starts.

Open the Start/Settings/Control Panel/Administrative Tools/Services menu in Windows® 2000. After selecting the MRRService, stop and start it directly with the short cuts or open the **Properties menu** and use the **Stop** and **Start** buttons.

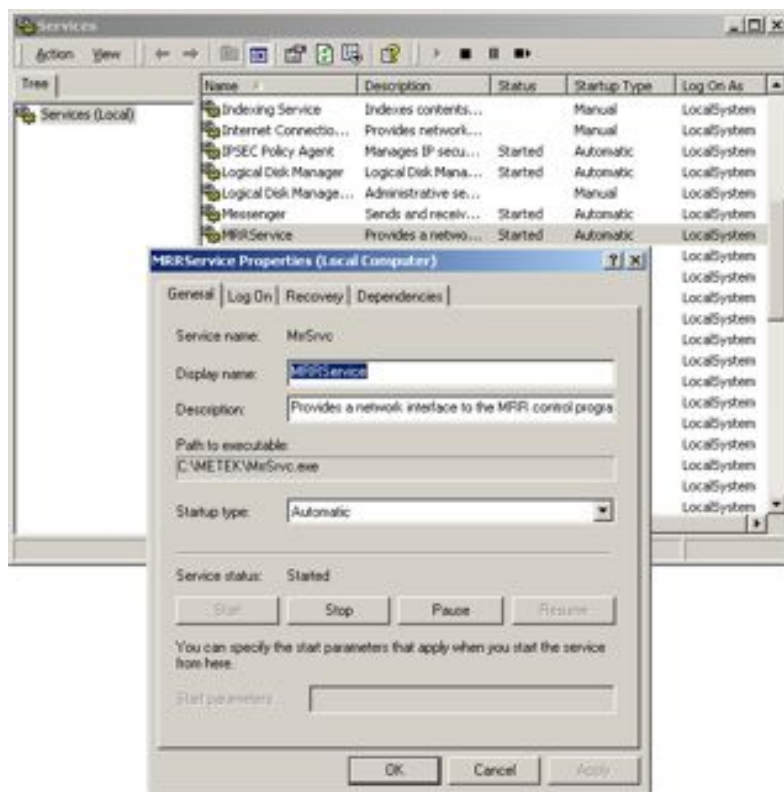

**Figure 19 Administrative Tools / Services – Menu (Windows® 2000)**

# CETECOM ICT Services GmbH

EC Identification number 0682

authorized by the German Government



to act as Notified Body in accordance with the R&TTE Directive 1999/5/EC of 09. March 1999.

## CERTIFICATE EXPERT OPINION

Registration-No.: E814169R-EO  
Certificate Holder: METEK  
Meteorologische Meßtechnik GmbH  
Fritz-Straßmann-Str. 4  
D-25337 Elmshorn  
Product Designation: Mikro-Regen-Radar (MRR) / PreWeS24  
Product Description: Radar System  
Product Manufacturer: METEK  
Meteorologische Meßtechnik GmbH  
Fritz-Straßmann-Str. 4  
D-25337 Elmshorn

Essential requirements	Specifications / Standards	Submitted documents	Result
Radio spectrum (R&TTE, Article 3.2)	EN 300 440-1 V1.3.1 (2001-09) EN 300 440-2 V1.1.1 (2001-09)	Test Report	conform

Marking: The product shall be signed with CE, our notified body number and the Class II identifier (Alert sign) as shown right hand.



The scope of this evaluation relates to the submitted documents only.  
The certificate is only valid in conjunction with the following number of annexes.

Number of annexes: 1

Saarbrücken, 18.10.2004  
Place, Date of Issue

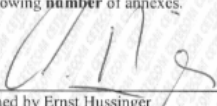
  
Signed by Ernst Hussinger  
Notified Body



CETECOM ICT Services GmbH, Untertürkheimer Straße 6-10, D-66117 Saarbrücken, Germany  
<http://www.cetecom.de>

# CETECOM ICT Services GmbH

EC Identification number 0682

authorized by the German Government



to act as Notified Body in accordance with the R&TTE Directive 1999/5/EC of 09. March 1999.

## CERTIFICATE EXPERT OPINION

Registration-No.: E814169R-EO  
 Certificate Holder: METEK  
 Meteorologische Meßtechnik GmbH  
 Fritz-Straßmann-Str. 4  
 D-25337 Elmshorn  
 Product Designation: Mikro-Regen-Radar (MRR) / PreWeS24  
 Product Description: Radar System  
 Product Manufacturer: METEK  
 Meteorologische Meßtechnik GmbH  
 Fritz-Straßmann-Str. 4  
 D-25337 Elmshorn

Essential requirements	Specifications / Standards	Submitted documents	Result
Radio spectrum (R&TTE, Article 3.2)	EN 300 440-1 V1.3.1 (2001-09) EN 300 440-2 V1.1.1 (2001-09)	Test Report	conform

Marking: The product shall be signed with CE, our notified body number and the Class II identifier (Alert sign) as shown right hand.



The scope of this evaluation relates to the submitted documents only.  
 The certificate is only valid in conjunction with the following number of annexes.

Number of annexes: 1

Saarbrücken, 18.10.2004  
 Place, Date of Issue

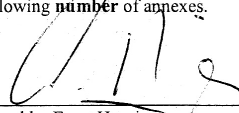
  
 Signed by Ernst Hussinger  
 Notified Body

